

	Serie / Type	
	P4LN0600 P4HN1000	P4LN0800 - P4HN1200 P4LN1000 - P4LN1200
SL=	28	35
DL=	22	28

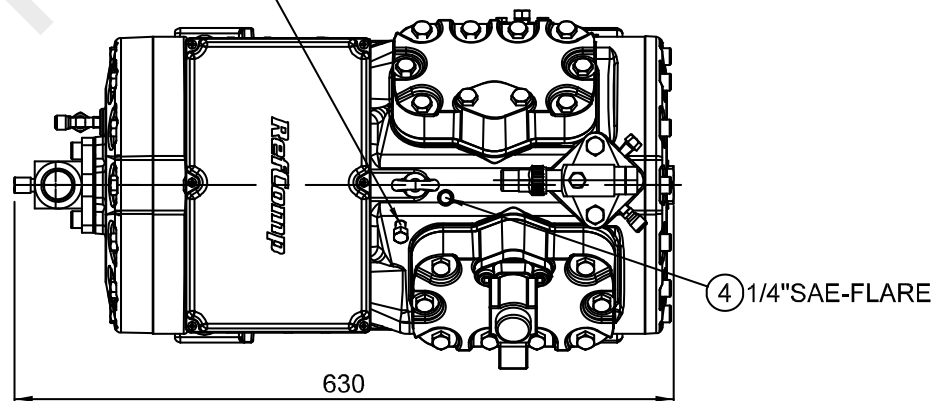
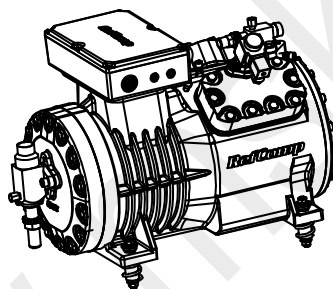

#### LEGENDA

- 1 - Rubinetto aspirazione
- 2 - Rubinetto scarico
- 3 - Alta pressione H.P.
- 4 - Bassa pressione L.P.
- 5 - Scarico olio
- 6 - Resistenza carter
- 7 - Spia livello olio
- 8 - Sensore temperatura di scarico 1/8"NPT (opzionale)
- 9 - Rubinetto carica olio 1/4" NPT (opzionale)
- 15 - Attacco raccordo iniezione LCM 1/8"NPT
- 16 - Equalizzazione olio (operazione parallelo)
- 17 - Equalizzazione gas (operazione parallelo)

#### KEY

- 1.- Suction shut-off valve
- 2.- Discharge shut-off valve
- 3- High pressure H.P.
- 4- Lowpressure L.P.
- 5- Oil drain
- 6- Crankcase heater
- 7- Oil level sight glass
- 8- Discharge temperature sensor 1/8" NPT (optional)
- 9- Oil charge valve 1/4" NPT (optional)
- 15- LCM injection connection 1/8"NPT
- 16- Oil equalization (parallel operation)
- 17- Gas equalization (parallel operation)

Piston compressor SP-4LN120E

**RefComp**